

## INSTRUCTION MANUAL

# *Duck-R*

T 002

**Rope Access Back-Up Device**  
CE 0120 EN 12841 Type A



## **WARNING**

All users must read and understand this manual before use. This product must only be used by persons who are trained and competent in its use as part of a double rope access system. Users accept all risks and responsibilities for all damage, injury or death during all rope access activities involving the use of this product. If users are not able to accept full responsibility or all risks involved they should not use this product. All users must be competent in emergency procedures and rescue methods associated with the use of this device. These are detailed in the 'Deployment' section of these instructions. Users should take great care that hair, fingers, clothing or other items do not become entangled with the Duck-R. DO NOT allow anything to affect the proper function of the device.

**Do not use the device for any other purpose.**

**INDIVIDUALLY TESTED**



Made in Brazil - SAFE TEC INDUSTRIA

**[www.safetecbr.com.br](http://www.safetecbr.com.br)**

# 1 PARTS & MARKING

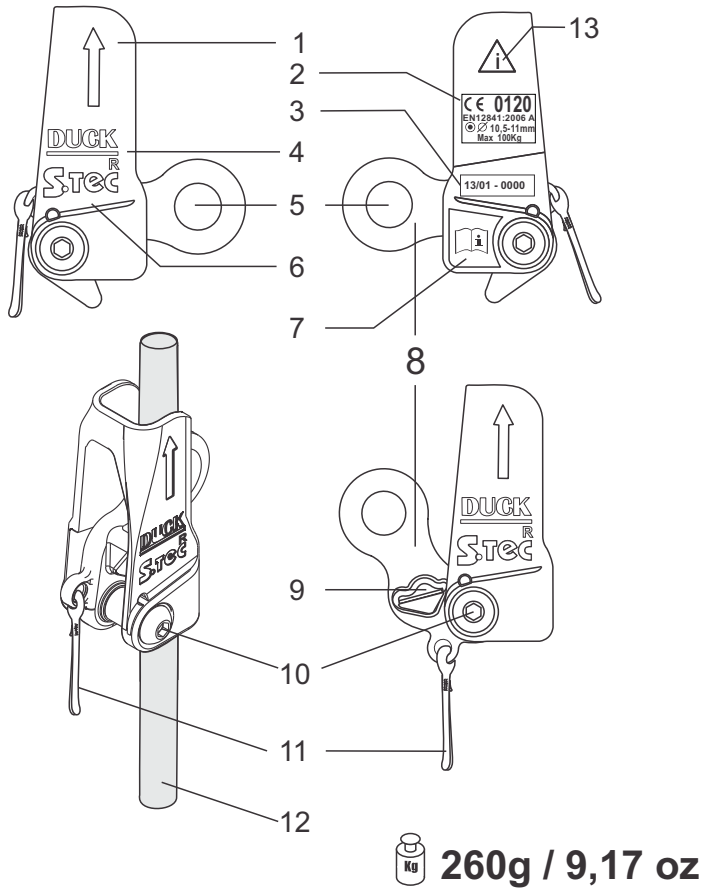

## PARTS

1. Body with Orientation Arrow pointing to Rope anchor.
2. Certification details\*
3. Serial Number
4. Model Name
5. Connection Point
6. Manufacturer's Logo
7. Read Instructions Logo
8. Cam
9. Friction Point
10. Bolt
11. Positioning Cord
12. Rope – not supplied
13. Warning logo

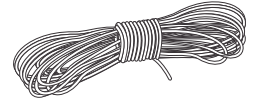

**Rope: 10.5 - 11mm**  
**EN 1891:1998 Type A**

## MARKINGS

### Materials

Body - Stainless Steel  
 Cam - Aluminium  
 Spring - Spring Stainless Steel  
 Cord - Nylon

### Rope Diameter

$\varnothing$  10.5 - 11mm  
 Rope Type: EN1891:1998 Type A

### Serial Number

E.g. 12 07-0000  
 12 – Year 2012  
 07 – Month – July  
 0000 – Unique Item Serial N°

### Certification

Notified Body:  
**CE 0120**  
**EN 12841:2006 A**

## LEGENDS

= Duck-R Back-Up Device	= Rope anchor
= EVO = Descender Device	= Max Load: 100 Kg (3527,39 oz)
= USER	= Operating Temperature -30 °C + 60 °C
	= Product weight: 260g (9,17 oz)

# 2 INSPECTION

This Duck-R must be inspected prior to each use. This inspection should check for any corrosion, cracks, evidence of abrasion, deformation, loose bolt or missing components together with full function test and markings are clear and readable. In addition to pre-use checks a regular detailed examination should be carried out by an authorized competent person at suitable periods and recorded, these should be at no more than six months intervals and these instructions must be adhered to. Following any emergency loading the Duck-R must be removed from service for examination. If any change is not 100% confident that the Duck-R is fit for use, it must be removed from service for further investigations. Devices passing inspection should only be re-used once written records are completed.

### Normal Wear:

The Cam will wear with use and this should be monitored.

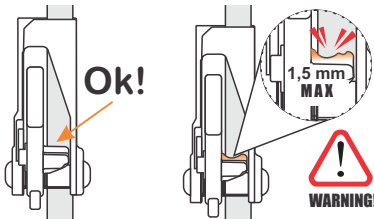

### INSPECTION



**Maximum allowable Cam wear 1.5 mm**

**IMPORTANT - Keep Cam Spring Lubricated. See section 16.**

# 3 FIELD OF APPLICATION

The Duck-R has been tested in the UK by SGS to the requirements of EN 12841:2006 Type A - Rope Adjustment Device, using Teufelberger 11mm and Edelrid 10.5mm EN1891 Type A Low Stretch Ropes. Other ropes have provided excellent results – check all different ropes prior to use. To be used in conjunction with EN 12841 Type C or B device, each device attached to independent ropes. Each attached to independent anchors with minimum strength of 15kN. Terms: 'Back-Up Rope' is used to describe the 'Safety Line' as termed in EN 12841 2006. 'User' refers to individuals or persons selecting this device for use.

# 4

## COMPATIBILITY

**Harness:** Front attachment point of an EN361 2002 or EN813 2008 harness.

**Lanyard:** It is recommend that this Duck-R is used with a EN lanyards up to 60cm long.

**Cows-tail** connection may be made using a dynamic climbing rope with suitable terminations, attached to either ventral (waist) or sternal (chest) points. Recommended length: waist <80cm, chest <50cm including any knots and connectors. Further information provided overleaf.

**Connectors:** EN 362 2004 Connector - Locking karabiner.

**Gloves:** the use of suitable work gloves is recommended.

**IMPORTANT - Keep Cam Spring Lubricated. See section. 16**

The Duck is a non-aggressive device and during correct operational use it will not damage ropes. In emergency deployment (see 'Deployment' section) with the exception of very minor glazing a properly used Duck-R will lock on to the Back-Up rope without causing serious damage to itself, its lanyard, karabiners or to the Back-Up rope. The user is responsible for ensuring the combination of all components in the rope access system do not adversely affect the performance of any item with due regard to all user instructions.

# 5

## INSTALLATION

Always install the Duck-R from a position of safety or when two additional safety systems are in place.

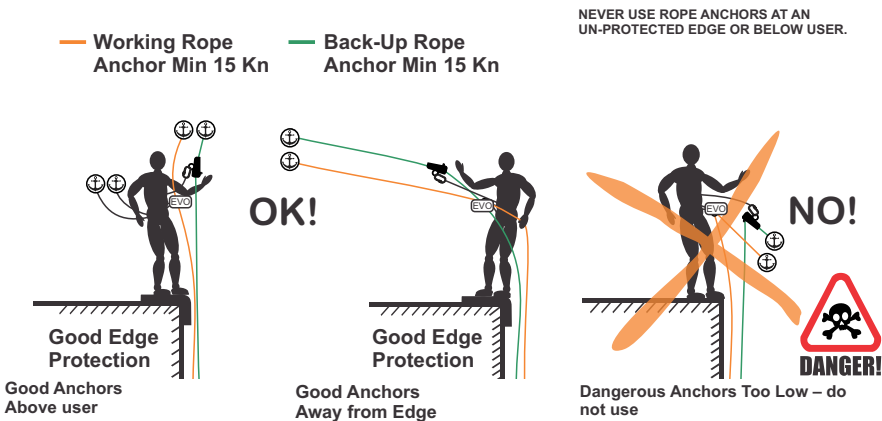

# 6

## STAGES OF INSTALLATION

1. Push the cam through the device body to the opposite side and attach the lanyard karabiner; this helps to prevent dropping the device.



2. Attach the device on to the rope with the 'Arrow' pointing in the direction of the rope's anchor.

3. Remove the lanyard karabiner and allow the cam to return through the device body.

4. Attach the lanyard karabiner to the connection point, check that the karabiner gate is fully closed and locked.

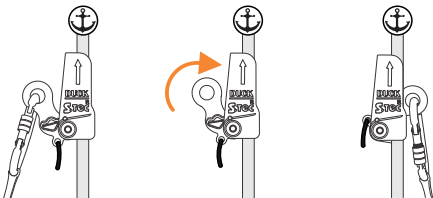

# 7

## OPERATIONAL CHECK - FUNCTION TEST

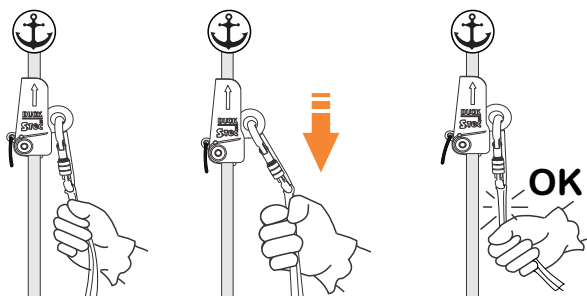

Move the device along the rope and check that it stays in position, then with one hand holding the lanyard or cows-tail, pull down vigorously to verify that the device locks on to the rope.

To maintain good spring action ensure that cam spring is lubricated regularly. See section 16.

## 8

## POSITIONING

At all times that the user is stationary the Duck-R should be positioned as high as possible. The Duck-R must always be above the descender or chest ascender and never below its lanyard/cows-tail attachment point (FF1)

**Ascent**

To move the Duck-R up the rope, hold the lanyard or karabiner- do not hold the device.

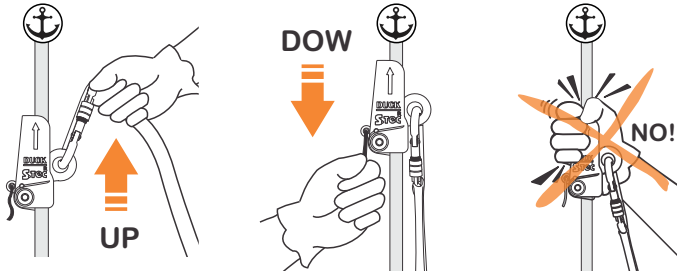
**Descent:**

The Duck-R backup device is fitted with a Positioning cord. Users must always perform full function checks of both their descent device and Duck-R before each descent.

To move the Duck-R down, pull the Positioning cord down using the index finger and thumb. Users should only hold the positioning cord for as short a period as necessary and ensure that they are prepared to let go of the Positioning cord immediately at all times.

In many applications the Duck-R should be controlled independently of the descent device, in others it may be necessary to control both Duck-R and descent device simultaneously. It is the responsibility of the user to carry out a risk assessment and determine which method is best for their operational activity and environment.

**WARNING**

If users keep hold of Positioning Cord the device will not function. Users must release their hold of the Cord immediately if anything unexpected occurs. At all times check the lanyard is not caught on obstacles and that it will not come in to contact with sharp edges, heat, tools or any other source of damage.

## 9

## OPTIMUM POSITION

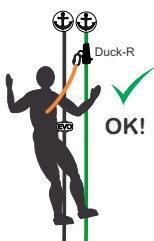

Keep it High  
High is Safe



Keep Control  
Take care



Take Action  
move Duck UP



DO NOT Hold the  
rope above the  
Duck-R



DO NOT HOLD  
or squeeze the  
Duck-R



DO NOT allow any  
slack in the rope  
above the Duck-R

## 10

## REMOVAL FROM ROPE

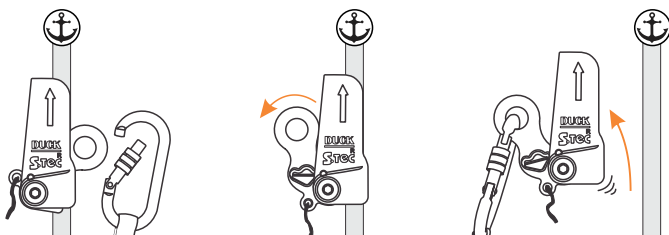
**Removal from rope**

To remove from the rope - disconnect the karabiner, pass the Cam through the body and re-connect the karabiner before pulling the device from the rope.

**WARNING**

Never leave the Duck-R on a rope with the karabiner attached to the Cam when it is pushed through the body.

## 11 SLOPING SURFACES

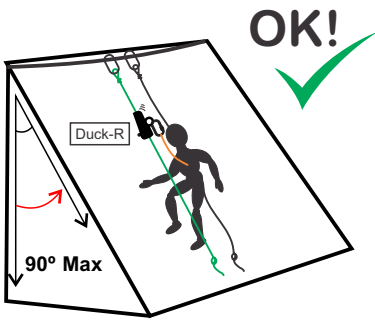

Keep Duck-R high on inclined plane

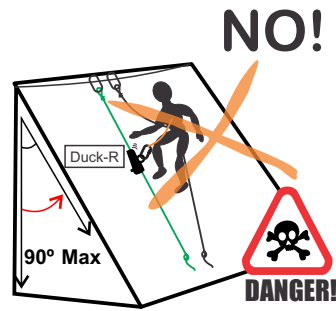

Keep Duck-R away from body

Ensure that nothing will affect the function of the Duck-R. Keep the device high and to one side of the user. Devices trapped between sloping surfaces and the user (or anything else) may not function properly.

## 12 WIND & OBSTACLES

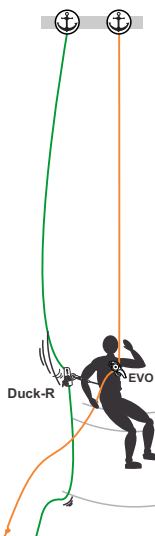

### Wind

The effect of Wind can create additional slack rope above the Duck-R, this must be managed at all times. It may be necessary to add friction to the Back-Up Rope below the Duck-R or pull rope through at work zones to partially load the device.

### Rope Obstacles

Great care is required if there are any devices, knots or other obstacles attached to the Back-Up Rope within 3m below the Duck-R. In these circumstances the Duck-R must be kept as high as possible with less than 10cm of slack in the lanyard or cows-tail until the obstacle is dealt with.

ATTENTION TO WIND SPEED.

## 13 CLEARANCE DISTANCE

### ROPE STRETCH



< 20cm slippage



>1m Fall + >20cm slippage



Serious fall + excessive slippage

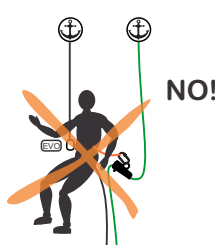

NO!

## 14 EXAMPLE BASED ON 10% ELONGATION



C - Clearance  
C = D x 10% + 2m

Additionally uncontrolled downward movement will occur due to the elongation of the Back-Up Rope during loading. This should be assessed for the particular rope being used but a minimum of 10% elongation should be expected.

The amount of elongation will depend on several factors including:

- I. Elongation Properties of the particular rope used;
- II. Length of rope between the Duck-R and the rope anchorage;
- III. Knot tightening;
- IV. Weight of user;
- V. Amount of slack in cows-tails/lanyards;
- VI. All other factors that must be determined by the user;

On long ropes the elongation will be many meters.

**Clearance** – The clearance distance must be carefully assessed for all situations.

At work positions when the device is positioned high and there is less than 10cm slack in the Lanyard or Cows-tail there will be very little slippage (e.g. a 100kg user less than 20cm). Additional slackness in the connecting lanyard increase slippage.

**WARNING**

The body of the Duck-R must NOT be squeezed or the Cord pulled to de-weight a loaded or partially loaded Duck-R.

**Accidental Deployment**

It is essential that all users are competent in the techniques required to overcome accidental loading. If accidental loading occurs during ascent, first check the ascent equipment, then continue ascending until the Duck-R is no longer under any loading. If loading occurs during descent, first check the descent equipment, then use techniques to complete a short ascent of the Working Rope until the Duck-R is no longer under any loading. Any other accidental loading should be assessed and appropriate methods used to overcome the loading. At all times two safety systems must be in place.

**Emergency Deployment**

If failure of the Working system e.g. Working Rope failure or user detachment from the Working Rope, occurs and the user becomes suspended on the Back-up Rope, the user and work colleagues must consider the planned procedural options available with regard to all factors of the actual event.

These options may include amongst others:

- I. The deployment and use of a new Working Rope;
- II. The rescue by a colleague using new ropes;
- III. The use of the Back-up Rope to attach escape equipment (descender or ascenders) for the user to evacuate on the single Back-up Rope;
- IV. Other techniques undertaken by competent persons.

All emergency actions should only be carried out following a risk assessment of the situation. During emergency deployment of the Back-up system any downward movement of the user will be determined by several factors: back-up rope stretch, cows-tail stretch, knot tightening and device slippage. With the exception of very minor glazing a properly used Duck-R will lock on to the Back-Up Rope without causing any damage to itself, lanyard, karabiners or the Back-Up Rope. Following any Emergency Deployment all equipment must be removed from service for inspection by a competent person.

**Rope Condition:** wear, wetness and contaminants will affect the performance of the Duck-R. Some rope conditions will make positioning of the Duck-R more difficult. Others e.g. oil & grease will affect the device's ability to perform - Back-Up may not be provided. The effective operation of the Duck-R should be monitored and checked in all conditions. Where any performance doubt exists, the Duck-R should not be used.

**Sea Water:** it is essential that this Duck-R is cleaned as soon as practicable after each exposure to sea water or saline environment.

**Chemical reagent:** avoid contact with any substance or material that may cause corrosion or other damage to the device. If contact occurs consult expert advice as to damage and cleaning requirements. Inspect prior to any re-use.

**Maintenance:** the Duck-R is not user maintainable with the exception of disinfection, cleaning and lubrication as detailed below.

**Disinfection:** following any contamination the source of the contamination should be determined and advice obtained as to suitable disinfecting procedure. After disinfection the device should be re-cleaned. Sterilisation may be required.

**Cleaning:** If soiled rinse in clean warm water of domestic supply quality (maximum temperature 40°C) with mild detergent at appropriate dilution (pH range 5.5 - 8.5). Dry naturally away from direct heat sources. To remove grease use a detergent that has properties that do not affect the metal spring, body, cam or nylon cord.

**Lubrication:** It is essential to maintain lubrication of the Cam spring. Lubricate regularly and after cleaning with light machine oil or teflon or silicone lubricant to ensure free movement of the cam. Wipe off the excess to avoid contamination of ropes and textile equip.

**Lifespan:** it is very difficult to define the safe lifespan due to varying use and storage conditions and may be as little as one use, or even earlier if damaged (e.g. in transit or storage) prior to first use. For the product to remain in service it must pass a visual and tactile examination. Maximum lifespan: 10 years from 1st use. Maximum Cam wear 1.5mm.

**Obsolescence:** this device may become obsolete before the end of its lifespan. Reasons for this may include changes in applicable standards, regulations, legislation, development of new techniques, incompatibility with other equipment etc.

**Transportation & Storage:** after cleaning store unpacked in a cool, dry, dark place in a chemically neutral environment away from excessive heat or heat sources, high humidity, sharp edges, corrosives or other possible causes of damage.

**Do not store wet.**

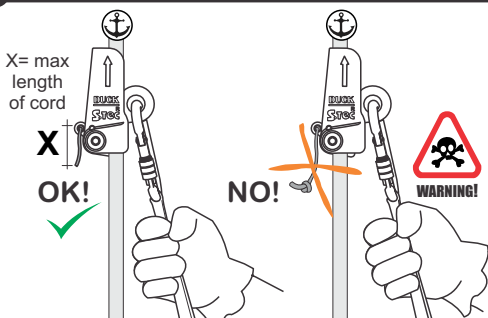

A positioning cord is factory fitted. If this becomes damaged or worn it can be replaced using cord. If 4mm cord is used it must be no longer than 40mm, 3mm cord must be no longer than 50mm. The only knot used must be to secure it tightly to the attachment point.

The CE mark has been attached to this product following type examination and testing by an accredited notified body N ° 0120 SGS UK Ltda, to the relevant European Standard. Each Duck-R is individually numbered and inspected. SAFE TEC INDUSTRIA do not recommend any user marking that affects the surface material or operational function.

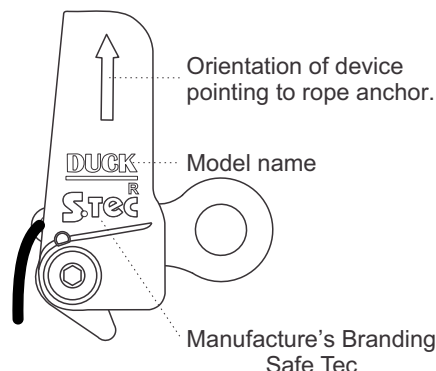

## 19 FURTHER INFORMATION ON MARKING

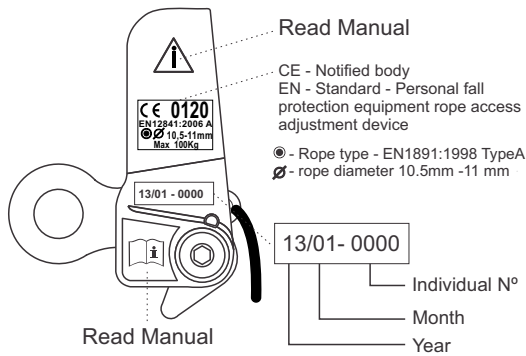

**ATTENTION:**

If marking with Users identification care must be taken to ensure that full function is maintained and the device is not damaged.

## 20 RESPONSIBILITIES

This product is guaranteed for 3 years against manufacturing faults. This excludes normal wear during use, corrosion due to incorrect storage, lack of maintenance or incorrect use. Uses outside those outlined in these instructions together with negligence or miss-use are also excluded. Safe Tec Industria accepts no responsibility for the selection of this device for user applications or any consequences resulting from the use of this device. No alterations or additions are to be undertaken without the prior written consent of Safe Tec Industria. For more informations of our latest version go to:

[www.safetecbr.com.br](http://www.safetecbr.com.br)

## 21 RECORD OF USE

<b>STEC</b>		
<b>Duck-R</b>		
Device	Stec - Duck-R	
Supplier		
Serial Number		
1 <sup>st</sup> Use	Expiry	
Acquisition date		
User Traceability		
<b>Record of Use and Periodic Examinations</b>		
Users should record details of use.		
Maximum period between Periodic Examinations is 6 months		
Date	User or Examiner	Details of Use-or Result of examination
Duplicate this sheet for continued recording. Contact Safe Tec for further information.		

[www.safetecbr.com.br](http://www.safetecbr.com.br)

Made in Brazil - SAFE TEC INDUSTRIA

## 22 FURTHER INFORMATION

### Lanyard – Cows-tail Length

Safe Tec acknowledge that the Duck-R has successfully passed the EN12481A – FF2 test with a 1m dynamic rope cows-tail, but do not advise or recommend its use in FF2 situations.

FF1 tests with a 1m cows-tails produce lower impact forces and less slippage-well below the maximum acceptable in EN12841A requirements. Safe Tec would recommend that with 1m cows-tail the FF should be kept below FF1.

The use of Lanyards/Cows-tails of lengths or material different to those recommended in the User Manual, should assess for the manner of intended use and all users competent to control the position of the device allowing for any increase (or decrease) in length with due regard to the function of the Duck-R.

All users must be aware of and paying attention to all factors associated with risks associated with slack in the lanyard, rope elongation/stretch, clearance, entanglement or other factors affecting the safety of users and performance of the device.

As recommended in the user manual; users should ensure optimally positioning at all times.

**Other Users:** The Duck-R has been used for applications that are outside the scope of EN 12841A and the CE mark attached to each device. The design of systems, planning and verification of system suitability for the specific intended applications is the responsibility of the user, all anchorages must be suitable for any load. Competence is required for all applications, additional safety measures must be implemented during training exercises, this must include the close supervision by competent instructor. Users must consider all sections of the user manual with special attention to the **Positioning Warning** and the information detailing **Clearance Distance** and **Rope Stretch** considerations and limitations. All installed devices should be independently function checked with suitable back-up in place prior to any rope operations.

### ON-ROPE RESCUE:

#### On-Rope Rescue:

Rescues should be planned and generally designed to limit the exposure of rescue team members. On-Rope Rescue should only be undertaken if the casualty is in urgent need of medical attention that requires evacuation. Additional training and competence is required for all persons performing rescues.

During all On-Rope Rescues the Duck-R must be kept above the shoulder height of both the rescuer and casualty. Where practicable Safe Tec recommend that one Duck-R be used for each person, each on its own rope and each controlled independently of the descent device.

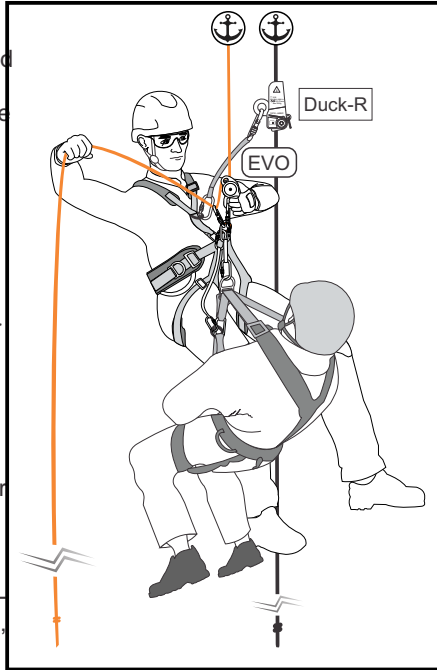

Rescue ropes must be suitably anchored and free from sources of damage. Users must consider all factors affecting Duck-R performance including obstacles, additional rope elongation and increase clearance requirements as well as all other sections in the user manual.

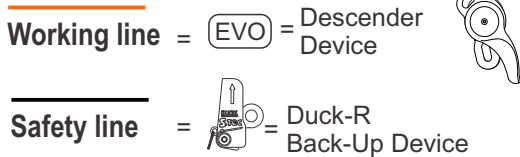

#### Green

Safe Tec recommend that all users aim for FF0 and minimum slack in cows-tails/lanyards.

#### Orange

Take extra care up to 50 cm fall distance - reposition Duck-R as soon as possible.

Would only give protection where there is sufficient clearance to avoid contact with any obstacles or surfaces having allowed for both elongation and slippage.

#### RED is Dangerous

Safe Tec do not suggest, condone or accept the use of the Duck-R in FF2.

*Indicative results above, using DMM 11 mm Work-Safe EN 1891A Semi-Static Rope.*

*Rope stretch (elongation) must always be allowed for - see Duck-R User Manual.*

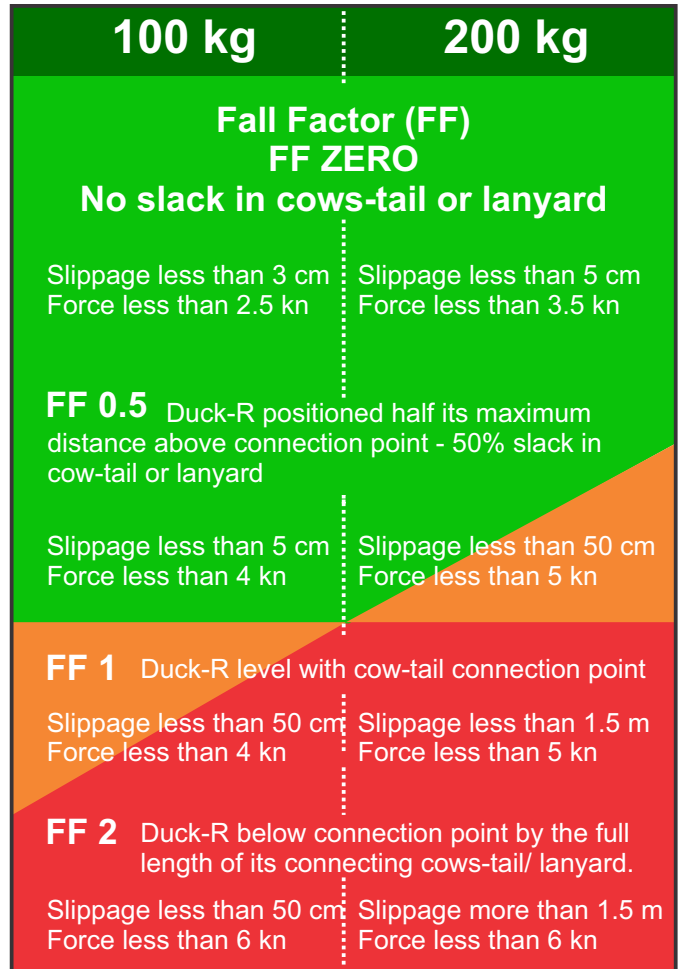

The Duck-R has successfully been tested by the manufacture to with loads of 200kg. This testing is designed to replicate rescue techniques and requirements with limited lanyard lengths and limited Fall Factors. The testing produced consistent performance.

## WARNING

#### Use on a loaded or pre-tensioned rope:

The Duck-R is designed to be used on an unloaded untensioned ropes as required in EN12841. The performance on a rope that has been deliberately tensioned must be verified prior to use. If during a rescue (or rescue training) a casualties ropes are to be used for access to the casualty; the performance of both the rescuers and the casualties back-up and main working systems must be assessed and performance verified prior to starting rescue access. Additional safety measures will normally be required, including additional training and equipment. For rescue training additional ropes and/or safety attachments is best practice.



## ADJUSTABLE RESTRAINT

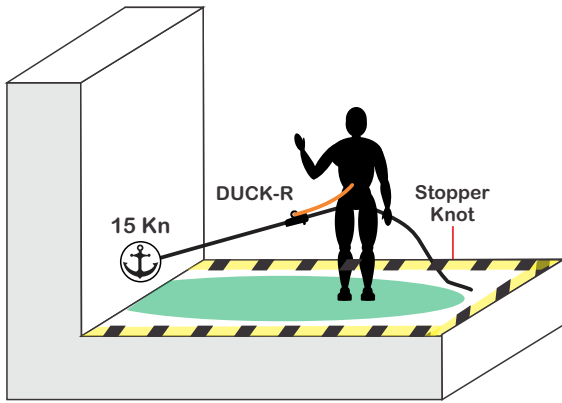

The Duck-R can be used as part of a planned restraint system of sufficient strength for any potential loading.

The length of available rope including Duck Lanyard must be shorter than the distance from its anchorage to any exposed edge or potential fall danger zone.

Where users are required to partially or fully load the system in any danger zone (e.g. to provide support or partial support) a second system must be in place prior to any loading.

## LOWERING EXAMPLE

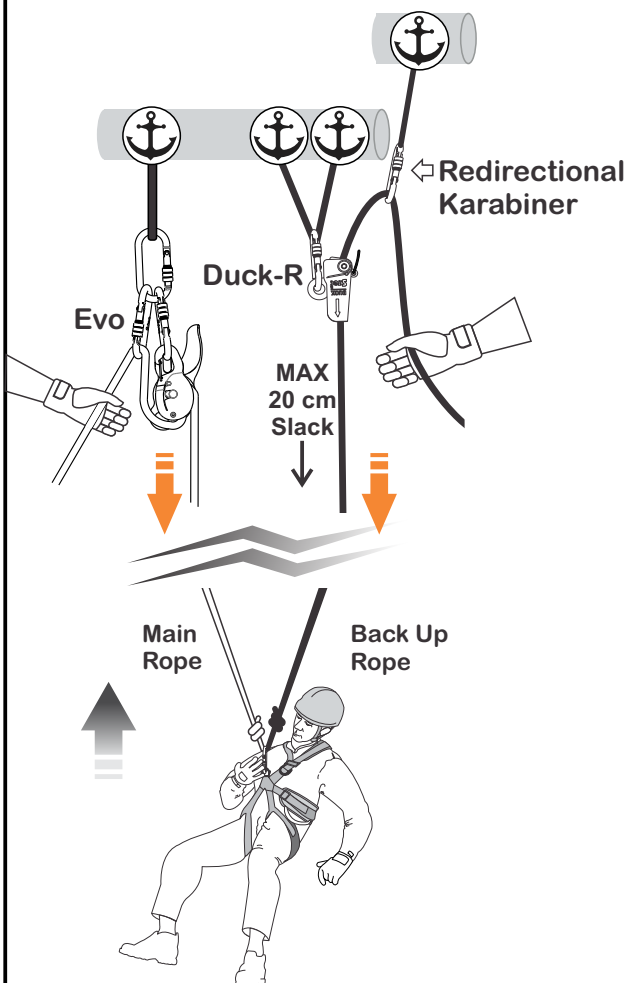

## HAULING EXAMPLE

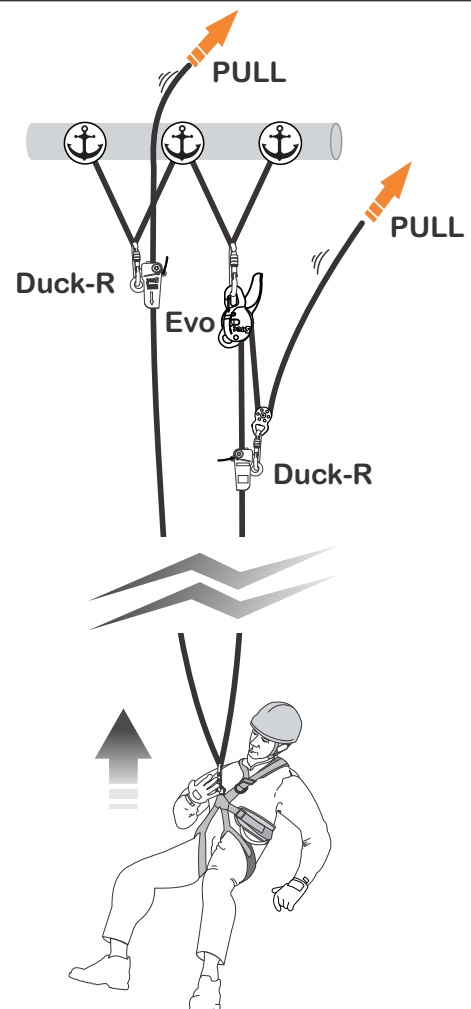

### Rescue - Hauling & Lowering:

Nothing should affect the proper function of the Duck-R in the event of any emergency loading. During use as a Back-up for a Hauling or Lowering System the Back-up rope must be attended to constantly and no more than 20cm of slack be allowed in the back-up rope, before repositioning the Duck-R.

Safe Tec recommend that the Duck-R is controlled by its own attendant so that optimum positioning can be maintained at all times.

Safe Tec recommend that two tensioned (equally loaded) ropes are the preferred choice in all **Hauling and Lowering Systems** - both ropes being hauled or lowered simultaneously and sharing the load. More than one person maybe required to operate Hauling or Lowering Systems

## TENSION SYSTEM

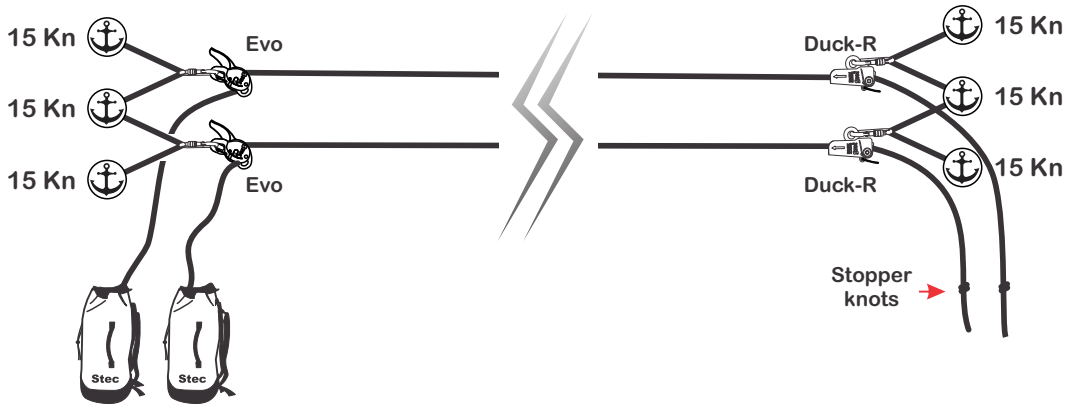

The use of the Duck-R to Anchor one end of a tensioned rope will provide an absorbing system, this will allow the rope to slip in the event of any overloading. Competent and trained persons who choose the Duck-R as part of a planned tension system must ensure that the loadings are within the capabilities of all components of the tension system - tensioned ropes greatly increase the load on anchorages, Safe Tec recommend a minimum of 30kN for the combined strength of all anchorages used for tensioned systems. Users must consider all other sections of this manual with special attention to the Positioning Warning and the information detailing Clearance Distance and Rope Stretch considerations and limitations. Safe Tec recommend that two simultaneously loaded tensioned ropes are the preferred choice in all Tension Systems.



CE 0120  
CE Certification Body  
Orgão Certificador SGS United Kingdom Ltd.  
Weston-super-Mare, BS22 6WA, UK.

[www.safetecbr.com.br](http://www.safetecbr.com.br)